

# E119 Fire Resistant Frame Solutions

## Interior Curtain Wall



Pioneer is pleased to partner with Vetrotech, a Saint-Gobain company to provide E119 Fire Resistive Interior Curtain Walls. This product is ideal for applications that require high span or multi-floor fire resistive construction that is also self supporting. E119 Fire Resistive Interior Curtain Walls has been tested and certified to ASTM E119, UL 263 and NFPA 251 standards. E119 Fire Resistive Interior Curtain Walls also meet the International Building Code for fire resistive rated frame requirements. Fire resistive rated frames and glazing blocks the passage of flames and also blocks the passage of excessive radiant heat and hot gases. This type of product is required by code for transom sidelight and fire window frames with greater than a 45 minute rating or where the glazed area exceeds 25% of the wall area.

### E119 Fire Resistive Glazing Maximum Sizes

Glass Type	UL Fire Rating	Visible Glass Width x Height	Max. sq. inch	Glass Thickness	STC (Level 3 Bullet Resistant)
Contraflam 60	60 Minute	94-13/16" x 94-13/16"	3283	1-1/8"	40
Contraflam Structure 60	60 Minute	138-1/2" x 138-1/2"	7574	1-1/4"	42
Contraflam 120	2 Hour	94-5/8" x 94-5/8"	4435	1-9/16"	46
Contraflam Structure 120	2 Hour	126" x 126"	4536	2-1/16"	46

### Options:

- Corner and angled frames
- Level 3 bullet resistant
- Sound rated glass up to STC 46
- Frames using Contraflam Structure without vertical mullions

### Applications:

Ideal for fire resistive applications that require high span (greater than 12 feet tall), self supporting construction

### Features:

- Fire resistive interior curtain wall configurations with 60 and 120 minute fire ratings
- Contraflam glass from Vetrotech fire resistive safety glass must be used. It contains an interlayer that becomes opaque in the event of fire and acts as a heat shield insulating against the fire
- All frames are primed painted or prefinished enamel over galvanized, chemically passivized (GVGC) steel
- Mechanically joined or fully welded construction
- Units have no maximum size since these products are tested and certified as wall assemblies

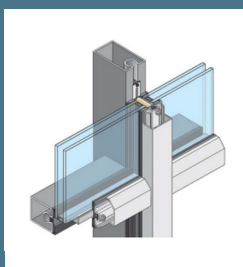

# E119 60 Minute Interior Curtain Wall

# E119 120 Minute Interior Curtain Wall

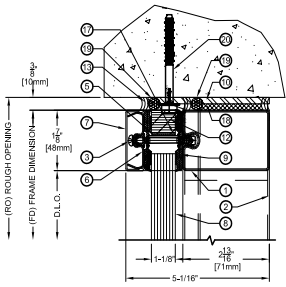

**A HEAD DETAIL**  
SCALE: N.T.S.

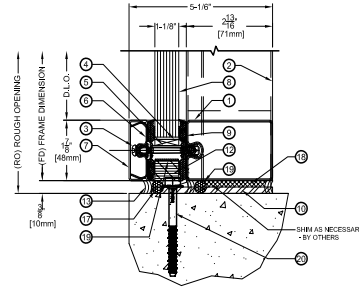

**B SILL DETAIL**  
SCALE: N.T.S.

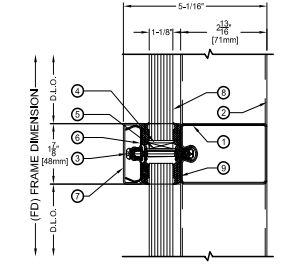

**C HORIZ. MULLION DETAIL**  
SCALE: N.T.S.

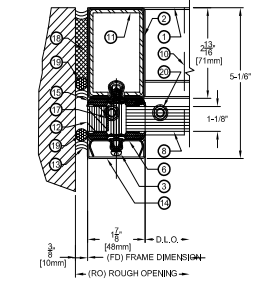

**D JAMB DETAIL - LEFT**  
SCALE: N.T.S.

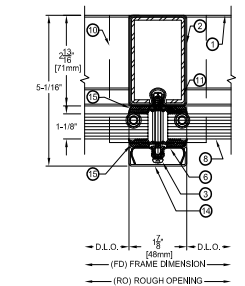

**E VERTICAL MULLION**  
SCALE: N.T.S.

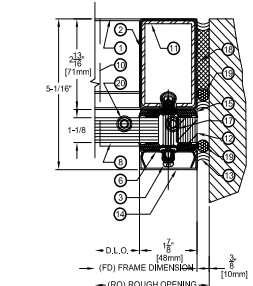

**F JAMB DETAIL - RIGHT**  
SCALE: N.T.S.

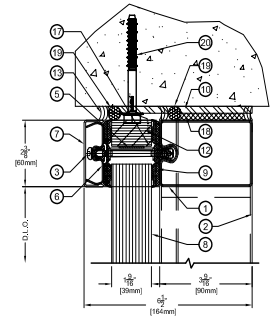

**A HEAD DETAIL**  
SCALE: N.T.S.

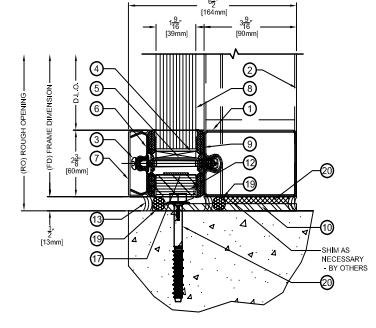

**B SILL DETAIL**  
SCALE: N.T.S.

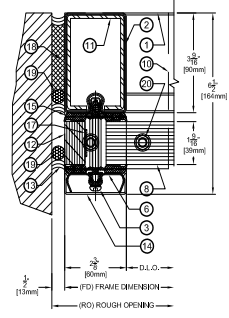

**D JAMB DETAIL - LEFT**  
SCALE: N.T.S.

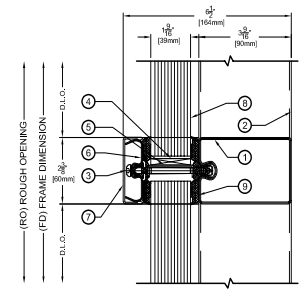

**C HORIZ. MULLION DETAIL**  
SCALE: N.T.S.

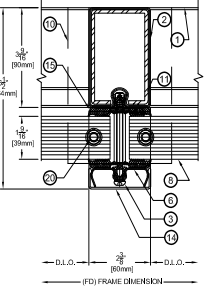

**E VERTICAL MULLION**  
SCALE: N.T.S.

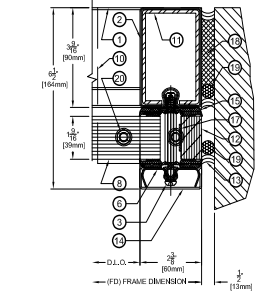

**F JAMB DETAIL - RIGHT**  
SCALE: N.T.S.

The ASSA ABLOY Group is the global leader in access solutions. Every day, we help billions of people experience a more open world.

ASSA ABLOY Opening Solutions leads the development within door openings and products for access solutions in homes, businesses and institutions. Our offering includes doors, frames, door and window hardware, mechanical and smart locks, access control and service.

111 Kero Road  
Carlstadt, NJ 07072  
Phone: 201-933-1900  
pioneerindustries.com

Pioneer is a brand associated with AADG, Inc., an ASSA ABLOY Group company. Copyright © 2019, AADG, Inc. All rights reserved. Reproduction in whole or in part without the express written permission of AADG, Inc. is prohibited.